

sedus

Desking range

temptation c







Who would have thought that work and leisure could harmonise so well?

There are desks. And then there's *temptation c*. So what's the difference? Whilst the former are merely functional, *temptation c* sets new standards when it comes to modern ergonomic workstations. In *temptation c*, Sedus has launched a

desk system which brings together design, ergonomics and economy. Various height-adjustment technologies allow the desk to be set to meet individual needs without compromising the clear-cut and aesthetically pleasing design line.

**Fascinating prospects for the coming
business year:
almost unbeatable efficiency.**



A flexible working environment increases productivity. The ergonomic C-frame and 4-leg frame desks from *temptation* can be freely combined with one another. For example as a workstation or conference system. The clean angular form is a

distinctive feature of the entire *temptation* family. *temptation c* is not only extremely economic but also future-proof! After all, it can be quickly and easily adapted to suit any situation.





Ergonomics versus economics. With temptation c, everyone's a winner.

Sedus *temptation c* provides a unique approach to customised workstation design which does not detract from the overall look of the office. With the individually adjustable desk top heights, this range makes a valuable contribution to a more pleasant and ergonomic work flow. The cupboards

with full height pull-out drawer not only offer lots of storage space but also act as room dividers with screening protection. Furthermore, they make ideal convergence points for stand-up meetings.



Practical. *Sedus temptation c* – the intelligent solution: individual workstations can be custom-equipped with the printer shelf, the laptop holder, the PC housing holder, etc. – all within arm's reach.

The perfect control centre. Even when all you want to do is relax.



You don't need a big office to show off *temptation c* to its best advantage. In an individual office or in a home office, the C-frame desk is an elegant piece of furniture. The attractive design of the freely select-

able worktops and frame components instantly add a sense of quality to any room. The Sedus mobile pedestal not only ensures that things are kept neat and tidy, it also optimises work flows.





Being organised is half the battle when it comes to keeping an eye on what really matters.

According to the saying, the state of one's desk reflects the state of one's mind. *temptation c* comes with a clear and tidy cable solution. All cables are concealed in the elegant E-Box or in the integrated cable management flap. And easy access from above provides an ideal solution for quickly connecting personal equipment.



Free from clutter. The sliding top provides direct access to the cable tray below the desk, fixed desktops can be fitted with a fold-down cable tray. On the desk, the cables are either guided through a panel on the side or through a cable management system. The desks also feature a stylish cable grommet and a handy desk-mounted socket outlet. Which means there are now no more excuses for a messy desk.



Elegant. Function and aesthetics in perfect harmony: the two-part cable management flap makes the cable dump invisible, whilst allowing convenient, easy access to power and data outlets whenever required. The brush section offers complete freedom when positioning the cable feed.



Simply twice as much room.

The double workstation with return table is a perfect example of the diverse combinations offered by *temptation c*. On the one side there is the actual desk and, on the other side, the additional surface can be used for storage. The return tables are robust and can be configured in any number

of ways. Ideal for all those for whom a single workstation is too small. The Sedus cushioned containers are particularly handy for visitors and colleagues; they make a comfortable seat for a spontaneous glance over the shoulder.



Face to face. Return tables can also be positioned centrally. So you can communicate with your team partner at any time, or switch dynamically between computer and discussion.

Good consultation starts at the desk.

With the numerous extension and linking elements, *temptation c* can be configured to meet all business needs. One of the options is the classic consultation scenario. In order to switch from the computer to the person you wish to talk to, simply swivel round to face him or her. You no longer need an alternative desk for meetings and, in turn, an uncluttered and harmonious office environment is ensured. The curvature of the desk offers enough surface as well as a relaxed and pleasant atmosphere for meetings.



System adapter. For mounting lights, screens, function bridges, etc.



Modesty panel. The modesty panel (plexi-glass, laminate or real wood veneer) ensures privacy from prying eyes.





Ergonomics begins where functionality ends.

With six different height settings, *temptation c* provides perfect ergonomics when working – whichever technology you opt for.





Height adjustment without the need for tools.

Simple and user-friendly, with an adjustment range of **620 to 850 mm**. The advantage: quick, individual adaptation

Height adjustment requiring tools.

Manually adjustable, with a large adjustment range of **620 to 850 mm**. The advantage: the most inexpensive height adjustment solution.



Height-adjustable via handle. For multi-user workstations, e.g., for call centres or shared desks. The advantages: simple adjustment (**620 to 850 mm**), no power supply required.



Height-adjustable via gas lift mechanism. Advantages: simple and quick adjustment, adjustment range with standing height from **720 to 1180 mm**, not dependent on power supplies, no costs for stand-by operation.



Motorized height adjustment. Advantages: simple adjustment with power supply, adjustment range with standing height from **720 to 1200 mm**, controller optionally available with digital display and memory function for four pre-selected heights.



Motorized height adjustment. Advantages: simple adjustment with power supply, adjustment range with standing height from **650 to 1250 mm**, controller optionally available with digital display and memory function (picture above) for four pre-selected heights.



Perfect for good communication style.

Intelligent functionality and efficiency are also key features of the conference tables in the *temptation c* product family. A range of desktop formats in several sizes, materials and colours are available to choose from. So you can create attractive configurations for team discussions to suit every requirement and room layout.



All aboard. The large boat shape provides space for up to ten people.



A perfect fit. You will also find ideal solutions for smaller meeting rooms.

Harmonised design.
Style and finishes
match the desking.



Communicative. The trapezium shape is ideal when using the *monitor caddy*, for training sessions and video conferences, for example.

Desks

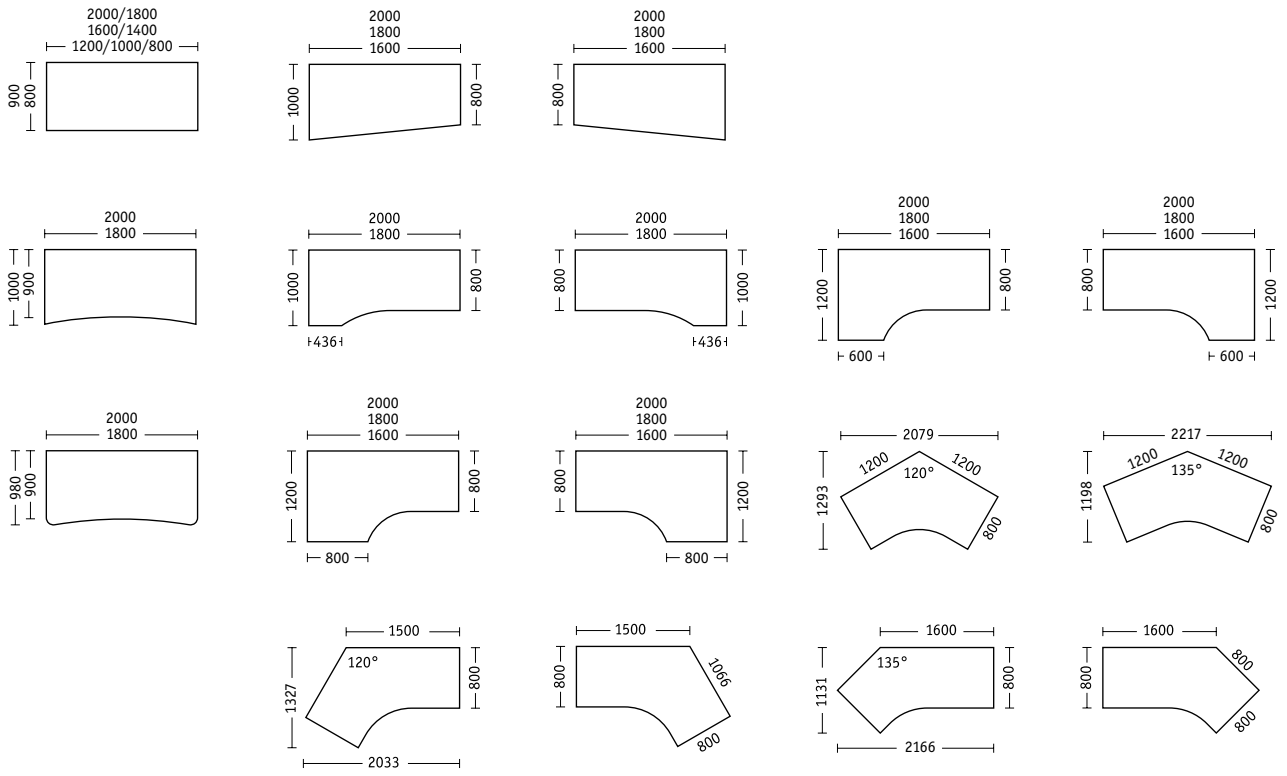

Return tables

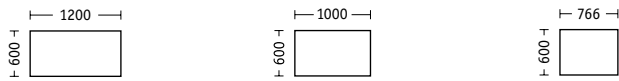

Side tables

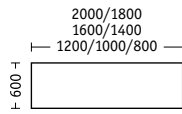

Linear table

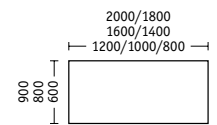

Extensions

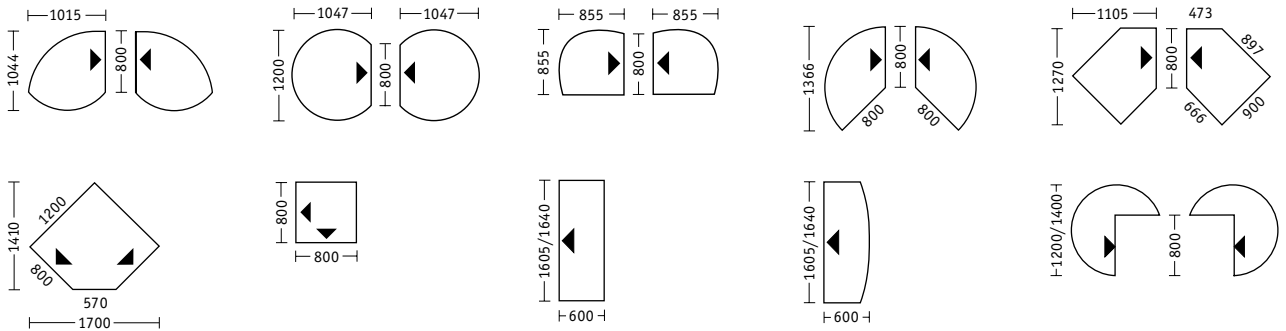

Conference tables

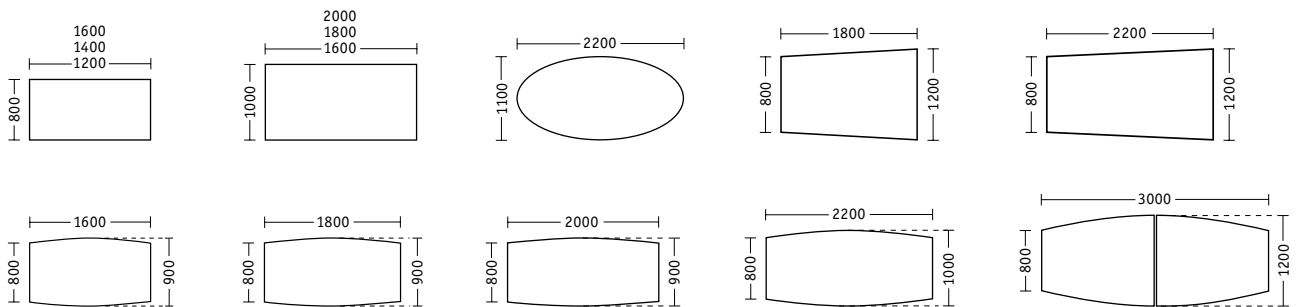

Dimensions in mm

Real wood veneer



E10 Ash white



E46 Ash light grey



H11 Maple natural



E41 Ash natural



F31 Cherry natural



B26 Beech natural



C11 Oak natural



B21 Beech mid brown



G11 Peartree natural



D12 Walnut natural



D11 Walnut dark



B23 Beech walnut varnish



C17 Oak wenge varnish



E45 Ash black

Laminate

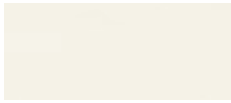

A14 pure white

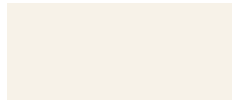

K74 natural white

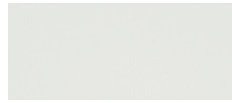

O2 arctic white



K69 Acacia



N10 likewood oak



203 Maple



103 Beech



K72 Olive



K66 Walnut



A16 dark grey



K70 graphite black



K65 Zebrano



K71 Ebony



K23 light orange



K24 sand



K25 turquoise



K26 green

Frame versions

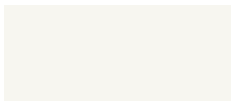

120 white



119 white aluminium

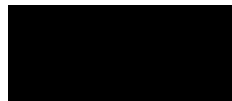

24 black

Modesty panel/desk screen Plexiglas

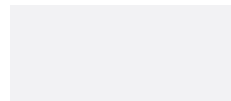

105 translucent white

Foot support



120 white



119 white aluminium



24 black



236 chromed

3. level

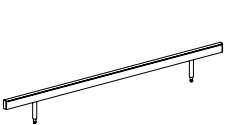

Function bridge

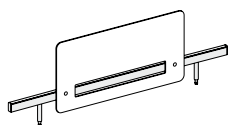

Plexiglas desk screen

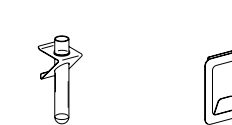

Flower vase



Picture frames



Cup holder

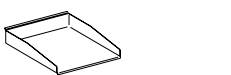

A4 long storage tray

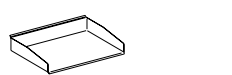

A4 wide storage tray



Wide pen tray

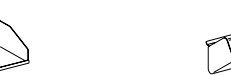

Notelet box 90 x 90 mm



Pen box



Sustainable through and through.

Sustainability and quality “Made in Germany” have been basic corporate principles at Sedus for more than 50 years. These principles are embodied in Sedus *temptation c* and reflected in the way we work: designing products which are recyclable, using ecologically tested materials, conserving resources, being energy-aware in our manufacturing and conducting ongoing quality tests.

For example, when producing the veneered *temptation c* desktops only selected woods such as beech, ash and oak from sustainably managed forests are used. State-of-the-art, energy saving and environmentally friendly production of the steel and aluminium components is also part of the quality and sustainability philosophy at Sedus.

Further information is available at www.sedus.com/se/en/philosophy/ecology

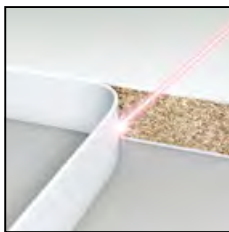

Innovative laser edge. Seamless edge processing of the highest quality creates a durable, attractive and environmentally friendly end product.



Native real wood veneers. A fascinatingly beautiful and environmentally friendly base material from sustainably managed forests.



Powder coating instead of paint finish. We employ the more eco-friendly and higher quality powder coating for finishing and protecting against rust.

Company:



Around the world, Sedus adheres to the principles of the UN Global Compact for human rights, labour standards, the environment and anti-corruption.

Sedus *temptation c*:



